

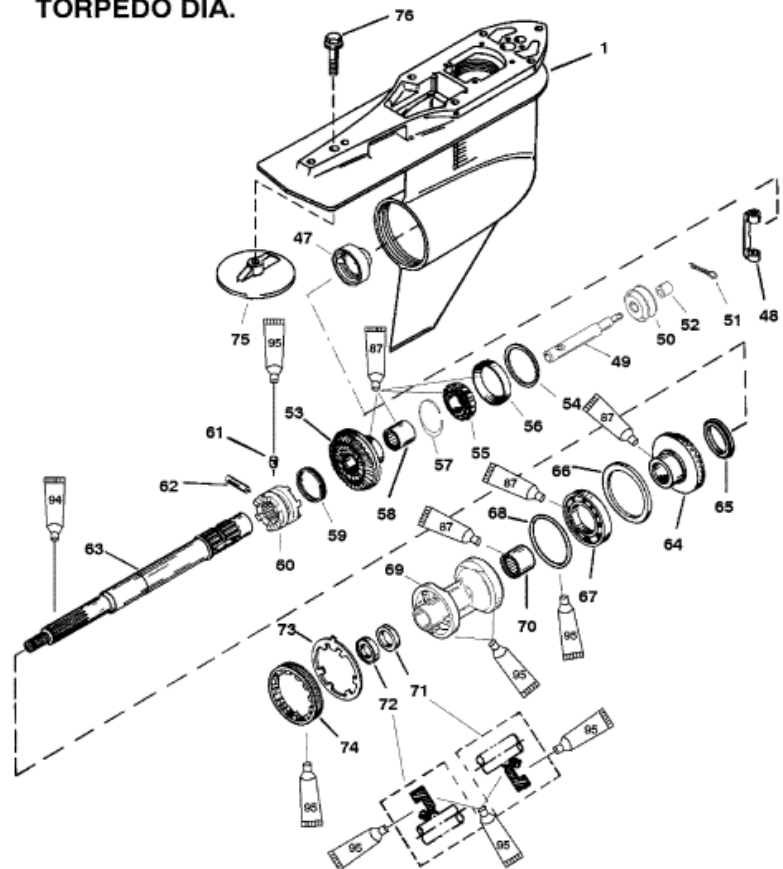







**4.75 IN/120.65MM
 TORPEDO DIA.**



-  87  94  95 Belray 65413 Gear Oil (92-816026)
-  94  95 Anti-Corrosion Grease (92-78376-A6)
-  95  96 Chemtool Duralube Special (92-824501)

Parts List						
Ref	Class	Part	Description	Qty	Comment	Footnote
1	1623	859399T18	GEAR HOUSING (BASIC)	1		
47	22	859403	PLUG	1		
48		823903	SHIFT CRANK	1		
49		19755T 7	SHAFT	1		
50		NSS	SHIFT SPOOL	1		
51	18	46950 1	COTTER PIN	1		
52		NSS	SLEEVE	1		
53	43	859321A 3	FORWARD GEAR	1	(1.75:1 - 12/21)	
54	15	44491A 1	SHIM SET	AR		
55	31	30894A 1	TAPERED ROLLER BEARING	1		
56		NSS	CUP	1		
57	53	856823	RETAINING RING	1		
58	31	30895T	ROLLER BEARING	1		
59	24	30893	SPRING	1		
60	52	859340T	SLIDING CLUTCH	1		
61	17	828356	DETENT PIN	1		
62	17	30632	CROSS PIN	1		
63	44	824110	PROPELLER SHAFT	1		
64	43	859322A 1	REVERSE GEAR	1	(1.75:1 - 12/21)	
65	23	824108	THRUST SPACER	1		
66		68100 1	THRUST RING	1		
67	30	88957T	BALL BEARING	1		
68	25	31534	O RING	1		15
69		818763T11	BEARING CARRIER	1		
70	31	30956T	ROLLER BEARING	1		
71	26	14077	OIL SEAL (INSIDE)	1		15
72	26	76868	OIL SEAL (OUTSIDE)	1		15
73	14	18323	TAB WASHER	1		
74		79448	COVER	1		
75		76214Q 5	ANODIC PLATE	1		
76	10	80632T	SCREW	1		
-	26	816575A 4	G/H SEAL KIT	1		